

PARALLEL NON-VOLATILE RAM

S-22 Series

The S-22 Series is a non-volatile CMOS RAM, composed of a CMOS static RAM and a non-volatile electrically erasable and programmable memory (E²PROM) to backup the SRAM. The organization is 256-word×4-bit (total 1K bits) for the S-22H12 and the S-22S12, and 64-word×4-bit (total 256 bits) for the S-22H10 and the S-22S10.

■ Features

- 1K bits
 - S-22H12 : TTL input, compatible with the X2212 of Xicor
 - S-22S12 : Schmitt input for $\overline{\text{STORE}}$ and $\overline{\text{RECALL}}$ pins
- 256 bits
 - S-22H10 : TTL input, compatible with the X2210 of Xicor
 - S-22S10 : Schmitt input for $\overline{\text{STORE}}$ and $\overline{\text{RECALL}}$ pins
- Erroneous store protection : ≈ 3.5 V
- +5-V single power supply (+5 V \pm 10%)
- Low current consumption
 - Operating : 10 mA typ.
 - Standby : 1 μ A max.
- Access time: 200 ns max.
- E²PROM store cycles : 10⁵ times
- E²PROM data retention: 10 years
- 18-pin DIP/SOP package

■ Pin Assignment

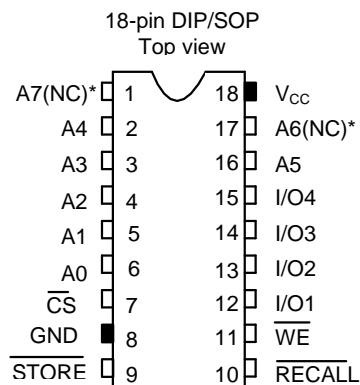

A0 to A7(A5)*	Address input
I/O1 to I/O4	Data input/output
$\overline{\text{WE}}$	Write enable
$\overline{\text{CS}}$	Chip select
$\overline{\text{RECALL}}$	Recall
$\overline{\text{STORE}}$	Store
GND	Ground
V _{CC}	Power supply voltage (+5 V)

*() is for the S-22H10 and S-22S10.

Figure 1

PARALLEL NON-VOLATILE RAM

S-22 Series

■ Block Diagram

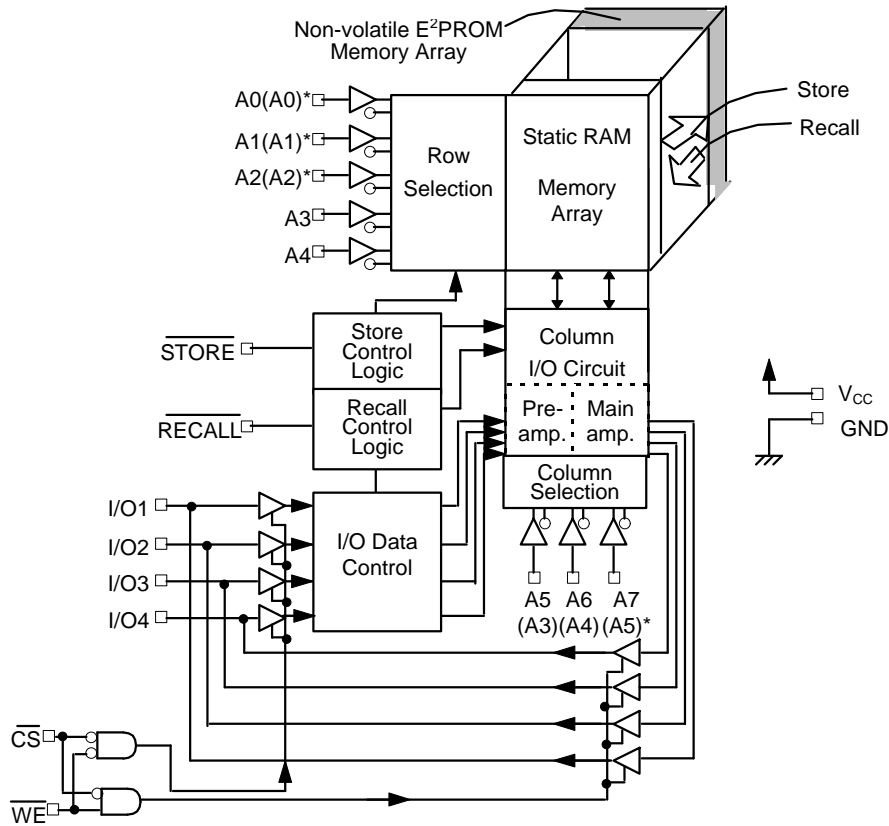

*() is for the S-22H10 and S-22S10.

Figure 2

■ Absolute Maximum Ratings

Table 1

Parameter	Symbol	Ratings	Unit
Power supply voltage	V_{CC}	-0.3 to +6.0	V
Input voltage	V_{IN}	-0.3 to $V_{CC}+0.3$	V
Output voltage	V_{OUT}	0.0 to V_{CC}	V
Storage temperature under bias	T_{bias}	-50 to +95	°C
Storage temperature	T_{stg}	-65 to +150	°C

■ Recommended Operating Conditions

Table 2

Parameter	Symbol	Conditions	Min.	Typ.	Max.	Unit
Power supply voltage	V_{CC}		4.5	5.0	5.5	V
High level input voltage 1	V_{IH}	S-22H Series : All inputs S-22S Series : CS, WE, I/O and address	2.0	—	V_{CC}	V
High level input voltage 2	V_{IHS}	S-22S Series : STORE and RECALL	3.4	—	V_{CC}	V
Low level input voltage 1	V_{IL}	S-22H Series : All inputs S-22S Series : CS, WE, I/O and address	0.0	—	0.8	V
Low level input voltage 2	V_{ILS}	S-22S Series : STORE and RECALL	0.0	—	0.8	V
Operating temperature	T_{opr}		-40	—	+85	°C

■ Pin Capacitance

Table 3

(Ta=25°C, f=1.0 MHz, V_{CC}=5 V)

Parameter	Symbol	Conditions	Min.	Typ.	Max.	Unit
Input capacitance	C _{IN}	V _{IN} =0 V	—	—	6	pF
Output capacitance (I/O pins)	C _{I/O}	V _{I/O} =0 V	—	—	10	pF

■ DC Electrical Characteristics

Table 4

(Ta=-40°C to 85°C, V_{CC}=+5 V±10%)

Parameter	Symbol	Conditions	Min.	Typ.	Max.	Unit
Operating current consumption	I _{CC}		—	10	30	mA
Standby current	I _{SB}	All inputs are V _{CC}	—	—	1	μA
Input leakage current	I _{LI}	V _{IN} =GND to V _{CC}	—	0.1	1	μA
Output leakage current	I _{LO}	V _{OUT} =GND to V _{CC}	—	0.1	1	μA
Low level output voltage	V _{OL}	CMOS : I _{OL} =100 μA	—	—	0.1	V
		TTL : I _{OL} =4.2 mA	—	—	0.4	V
High level output voltage	V _{OH}	CMOS : I _{OH} =-100 μA	V _{CC} -0.7	—	—	V
		TTL : I _{OH} =-2 mA	2.4	—	—	V
Store inhibition voltage	V _{WI}		—	3.5	4.1	V
Schmitt width	V _{WD}	S-22S Series : STORE and RECALL	0.4	—	—	V

■ Data Hold Characteristics

Table 5

Parameter	Symbol	Conditions	Min.	Typ.	Max.	Unit
Data hold voltage	V _{DH}	$\overline{CS} \geq V_{CC}-0.2V$, $\overline{RECALL} \geq V_{CC}-0.2V$	1.5	—	5.5	V
Data hold setup time	t _{CDH}		50	—	—	ns
Recovery time	t _R		300	—	—	ns

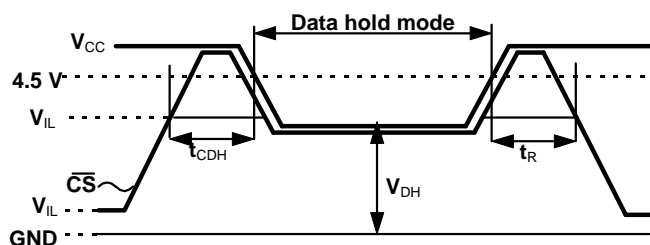

Figure 3 Data hold timing chart

PARALLEL NON-VOLATILE RAM

S-22 Series

AC Electrical Characteristics

Table 6 Measuring conditions

Parameter	Conditions	
Input pulse voltage	S-22H Series : All inputs S-22S Series : CS, WE, I/O and address	0.0 to 3.0 V
	S-22S Series : $\overline{\text{STORE}}$ and $\overline{\text{RECALL}}$	0.0 to 4.0 V
Input pulse rise/fall time		10 ns
I/O reference voltage		1.5 V
Output load		1TTL+100pF

1. Read cycle

Table 7

Parameter	Symbol	Min.	Typ.	Max	Unit
Read cycle time	t_{RC}	200	—	—	ns
Address access time	t_{AA}	—	—	200	ns
$\overline{\text{CS}}$ access time	t_{CS}	—	—	200	ns
Output data hold time	t_{OH}	20	—	—	ns
Output enable time ($\overline{\text{CS}}$)	t_{CLZ}	10	—	—	ns
Output disable time ($\overline{\text{CS}}$)	t_{CHZ}	10	—	70	ns

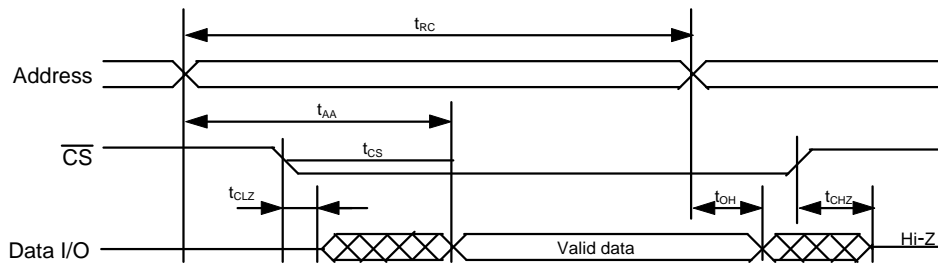

Figure 4

2. Write Cycle

Table 8

Parameter	Symbol	Min.	Typ.	Max	Unit
Write cycle time	t_{WC}	200	—	—	ns
$\overline{\text{CS}}$ pulse width	t_{CW}	120	—	—	ns
Address setup time	t_{AS}	20	—	—	ns
$\overline{\text{WE}}$ pulse width	t_{WP}	120	—	—	ns
Write reset time	t_{WR}	25	—	—	ns
Input data setup time	t_{DW}	50	—	—	ns
Input data hold time	t_{DH}	20	—	—	ns
Output disable time ($\overline{\text{WE}}$)	t_{WHZ}	10	—	70	ns
Output enable time ($\overline{\text{WE}}$)	t_{WLZ}	10	—	—	ns

• Write cycle 1 : \overline{WE} control

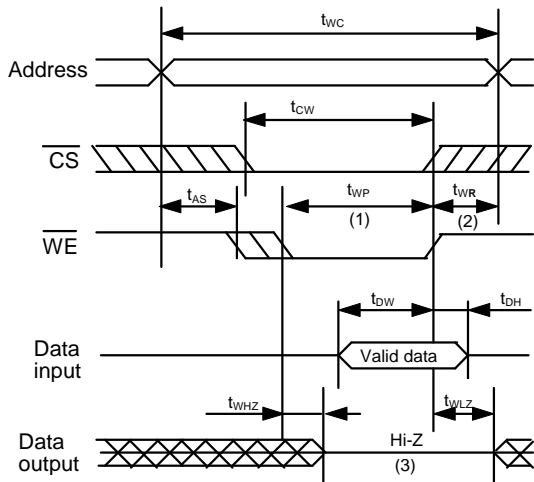

Figure 5

• Write cycle 2 : \overline{CS} control

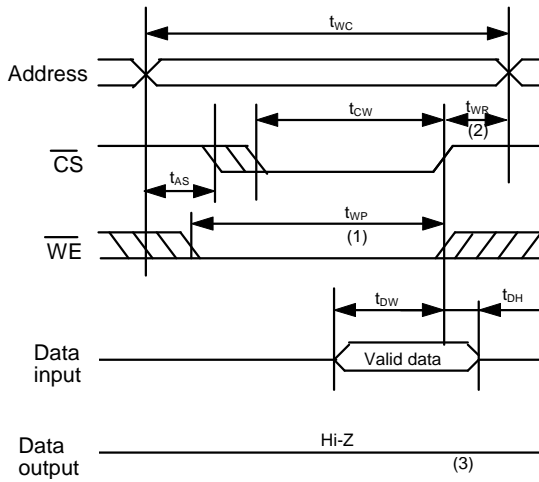

Figure 6

- (1) The write cycle starts when both \overline{CS} and \overline{WE} are low.
- (2) t_{WR} is the period of time from the rise of \overline{CS} or \overline{WE} whichever is the first to the end of write cycle.
- (3) Output remains in high-impedance state when \overline{CS} falls simultaneously with or after the fall of \overline{WE} .

3. Store Cycle

Table 9

Parameter	Symbol	Min.	Typ.	Max	Unit
Store time	t_{ST}	—	—	10	ms
Store pulse width	t_{STP}	200	—	—	ns
Store disable time	t_{STZ}	—	—	100	ns
Store enable time	t_{OST}	10	—	—	ns

Store operation starts at the falling of \overline{STORE} .

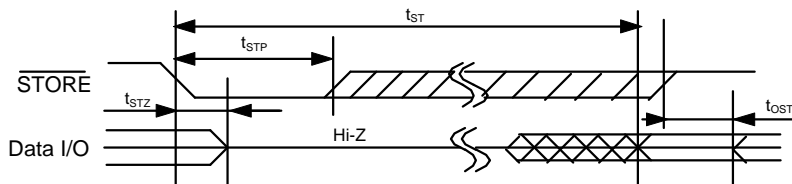

Figure 7

PARALLEL NON-VOLATILE RAM
S-22 Series

4. Recall cycle

Table 10

Parameter	Symbol	Min.	Typ.	Max	Unit
Recall cycle time	t_{RCC}	1300	—	—	ns
Recall pulse width	t_{RCP}	200	—	—	ns
Recall disable time	t_{RCZ}	--	—	100	ns
Recall enable time	t_{ORC}	10	—	—	ns
Recall data access time	t_{ARC}	—	—	1100	ns

Recall operation starts at the rise of $\overline{\text{RECALL}}$. It can be repeated without limitation.

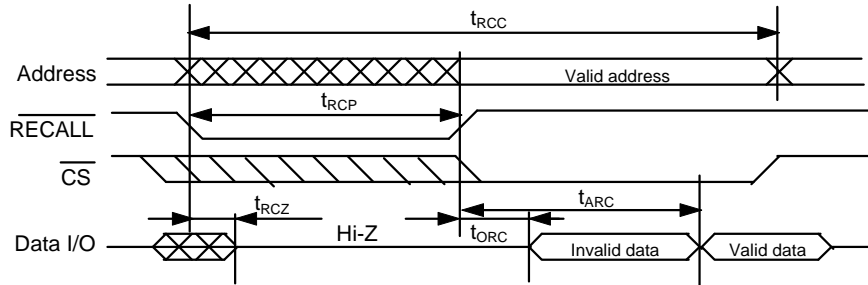

Figure 8

■ **Operation Mode**

Table 11

Mode	Input				Input/output
	$\overline{\text{CS}}$	$\overline{\text{WE}}$	$\overline{\text{RECALL}}$	$\overline{\text{STORE}}$	
Standby mode	H	X	H	H	Output is high impedance
Read mode	L	H	H	H	Output data
Write mode	L	L	H	H	Input data
Recall mode	X	H	L	H	Output is high impedance
Store mode	X	H	H	L	Output is high impedance
	H	X	H	L	

X : Don't care

- Notes
- When $\overline{\text{RECALL}}$ and $\overline{\text{STORE}}$ are simultaneously input, $\overline{\text{RECALL}}$ is valid.
 - When $\overline{\text{RECALL}}$ is low, $\overline{\text{STORE}}$ cannot be received.
 - When power supply voltage (V_{CC}) is below store inhibition voltage V_{WI} , the store operation is inhibited.

■ **Operation**

1. Standby mode

When $\overline{\text{CS}}$ goes high, the S-22 Series enters into the standby mode: power consumption becomes lowest, and I/O1 to I/O4 are high impedance.

2. SRAM modes

2.1 Read mode

When $\overline{\text{CS}}$ is low and $\overline{\text{WE}}$ is high, the S-22 Series enters into the read mode: the SRAM data is output to I/O1 to I/O4.

2.2 Write mode

When $\overline{\text{CS}}$ and $\overline{\text{WE}}$ are low, the S-22 Series enters into the write mode: the data input in I/O1 to I/O4 is written to the SRAM.

3. SRAM \leftrightarrow E²PROM mode

3.1 Store mode

When $\overline{\text{STORE}}$ goes $V_{IL}(V_{ILS})$, the S-22 Series enters into the store mode: the SRAM data is copied to the E²PROM. The original data in the SRAM is effective. Since the copied data in the E²PROM is non-volatile, they are retained even if power turns off. When $\overline{\text{STORE}}$ falls, the store operation starts and finishes automatically. When store operation starts, I/O1 to I/O4 go to high impedance and other operations are inhibited until store operation is finished and $\overline{\text{STORE}}$ goes to high. During store operation, the CPU can access other instructions. The store operation is inhibited if power supply voltage (V_{CC}) is under V_{WI} (≈ 3.5 V). The following two methods prevent erroneous store, caused by noise when power turns on or off:

- $\overline{\text{RECALL}}$ goes $V_{IL}(V_{ILS})$ when power turns on or off (see Figure 9).
- $\overline{\text{STORE}}$ connects to V_{CC} with pull-up resistor.

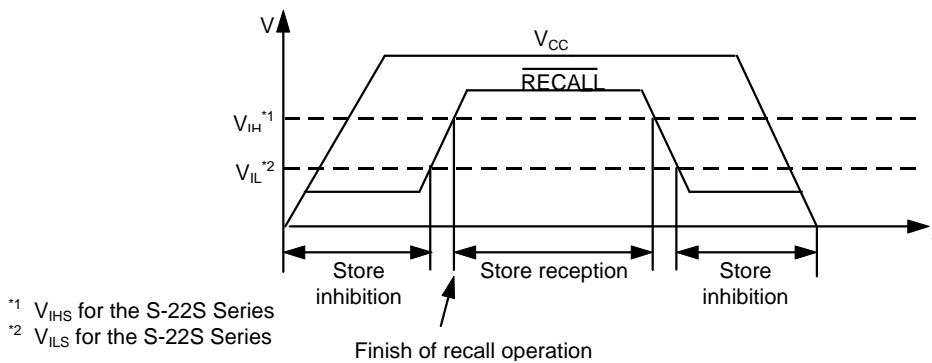

Figure 9 STORE inhibition period and reception period at power ON and OFF

3.2 Recall mode

When $\overline{\text{RECALL}}$ goes $V_{IL}(V_{ILS})$, the S-22 Series enters into the recall mode: the data copied into the E²PROM is recopied to the SRAM. The recopied data can be read or written as SRAM data. Even if the data is copied repeatedly, the data in the E²PROM does not change. Other operations are inhibited during its operation.

PARALLEL NON-VOLATILE RAM
S-22 Series

■ **Ordering Information**

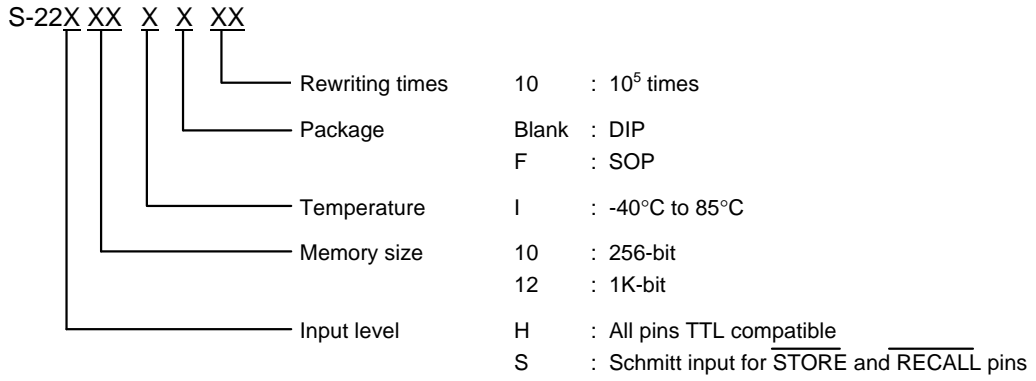

■ Characteristics

1. DC Characteristics

1.1 Operating current consumption I_{CC} – Power supply voltage V_{CC}

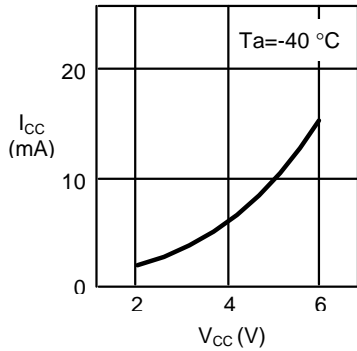

1.2 Operating current consumption I_{CC} – Ambient temperature T_a

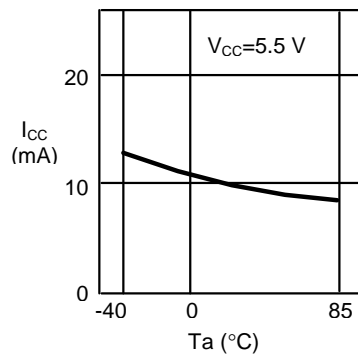

1.3 Operating current consumption I_{CC} – Reading frequency

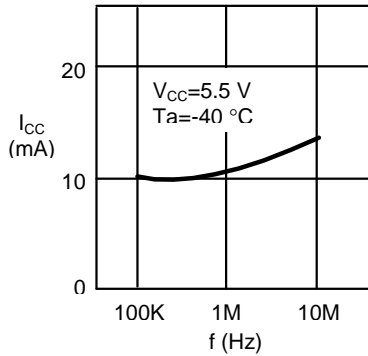

1.4 Standby current consumption I_{SB} – Ambient temperature T_a

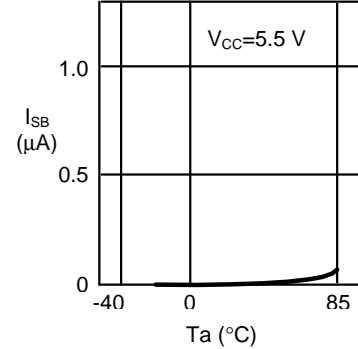

1.5 High level input voltage V_{IH} – Ambient temperature T_a
S-22H Series : All inputs
S-22S Series : CS, WE, I/O and address

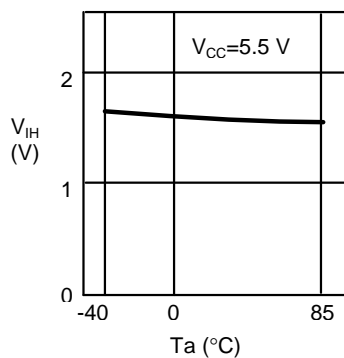

1.6 Low level input voltage V_{IL} – Ambient temperature T_a
S-22H Series : All inputs
S-22S Series : CS, WE, I/O and address

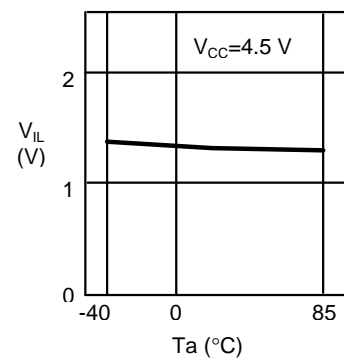

1.7 High level input voltage V_{IHS} – Ambient temperature T_a
S-22S Series : STORE and RECALL

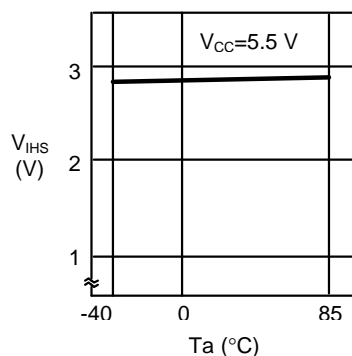

1.8 Low level input voltage V_{ILS} – Ambient temperature T_a
S-22S Series : STORE and RECALL

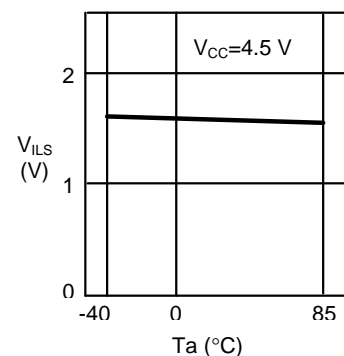

PARALLEL NON-VOLATILE RAM
S-22 Series

2. AC Characteristics

2.1 Address access time t_{AA}
 – Ambient temperature T_a

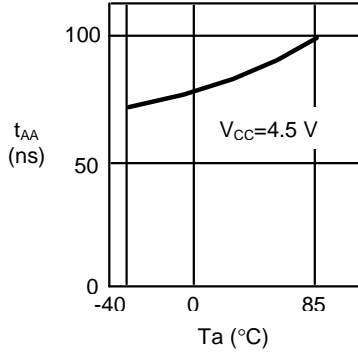

2.2 CS pulse width t_{CW}
 – Ambient temperature T_a

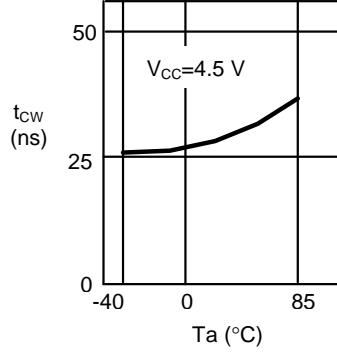

2.3 WE pulse width t_{WP}
 – Ambient temperature T_a

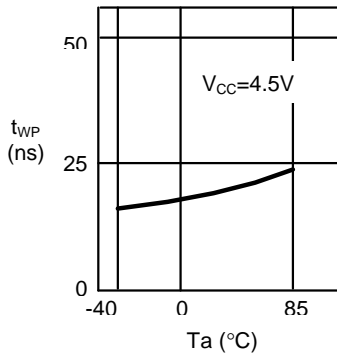

2.4 Input data setup time t_{DW}
 – Ambient temperature T_a

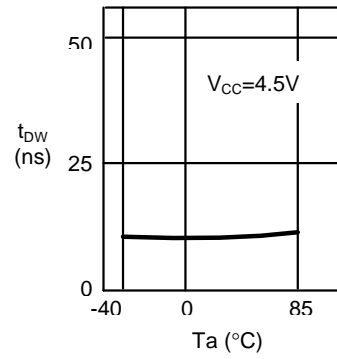

2.5 Store time t_{ST}
 – Ambient temperature T_a

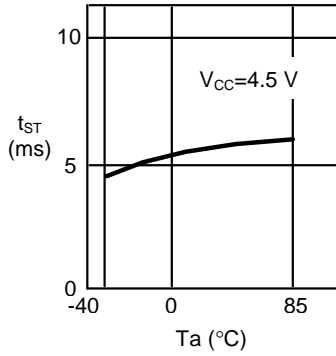

2.6 Recall cycle time t_{RCC}
 – Ambient temperature T_a

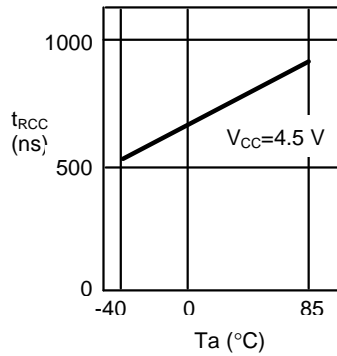

3. Rewriting Characteristics

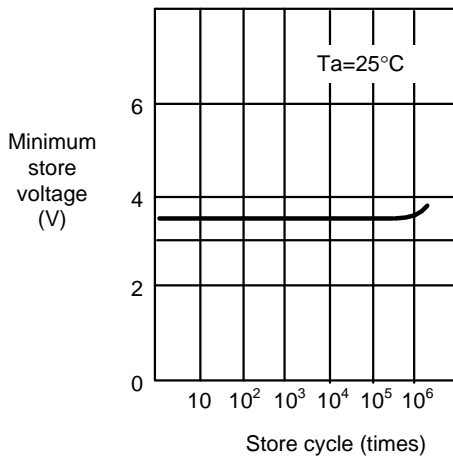

18-pin SOP

FE018-A 990531

Dimensions

Unit:mm

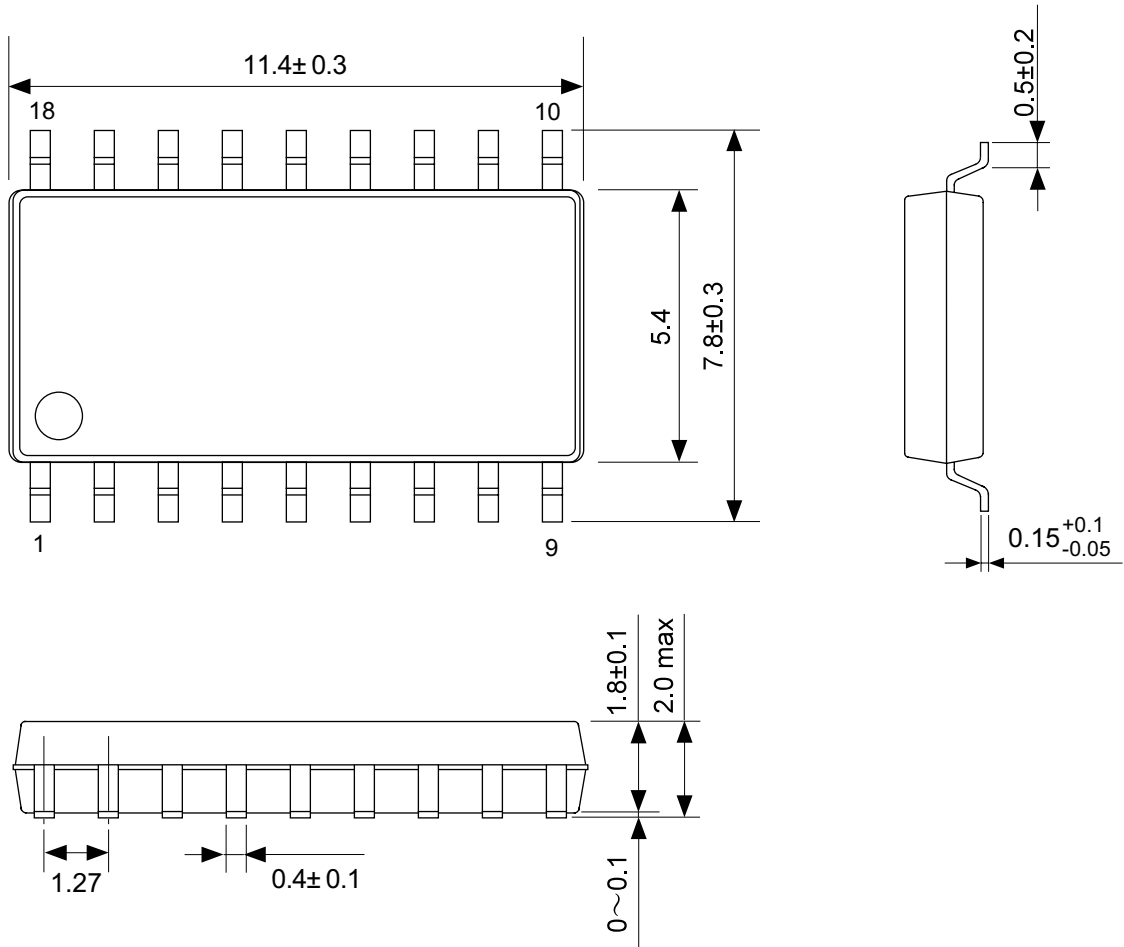

No. : FE018-A-P-SD-1.0

18-pin DIP

DP018-A 990531

Dimensions

Unit:mm

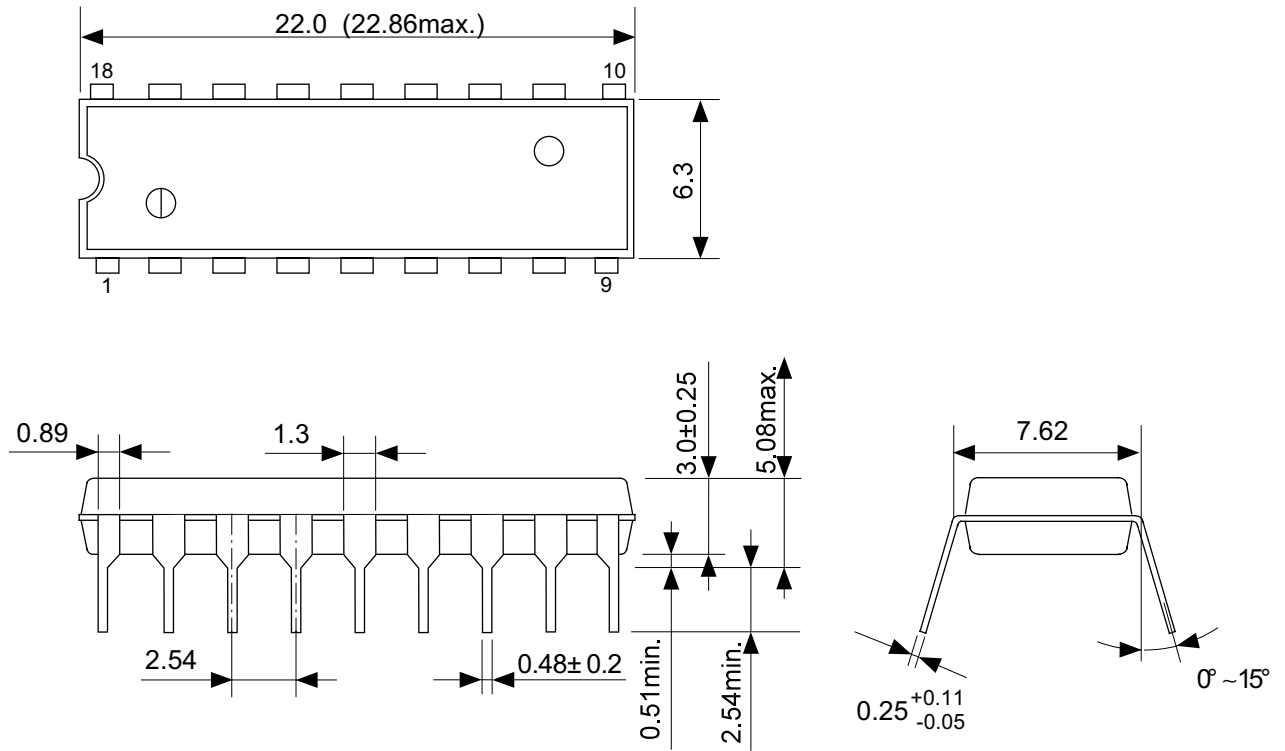

No. : DP018-A-P-SD-1.0

- The information herein is subject to change without notice.
- Seiko Instruments Inc. is not responsible for any problems caused by circuits or other diagrams described herein whose industrial properties, patents or other rights belong to third parties. The application circuit examples explain typical applications of the products, and do not guarantee any mass-production design.
- When the products described herein include Strategic Products (or Service) subject to regulations, they should not be exported without authorization from the appropriate governmental authorities.
- The products described herein cannot be used as part of any device or equipment which influences the human body, such as physical exercise equipment, medical equipment, security system, gas equipment, vehicle or airplane, without prior written permission of Seiko Instruments Inc.