

TOP COVER

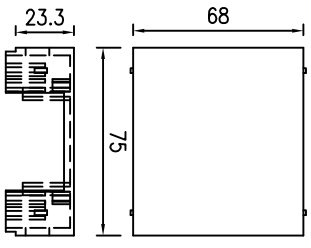

CASE BODY

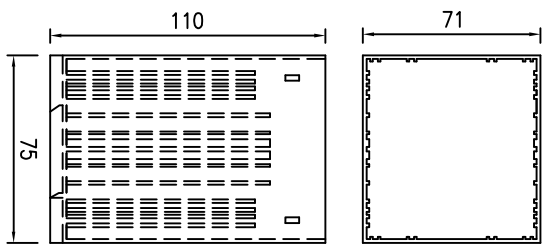

TERMINAL PCB

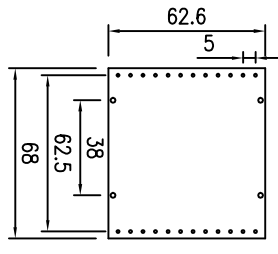

TERMINALS

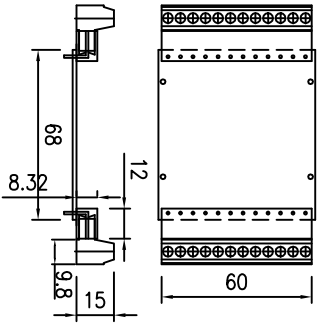

COVER ASSEMBLY

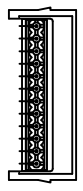
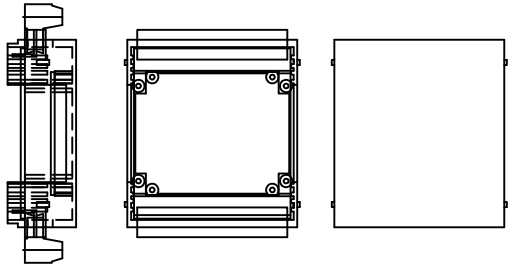
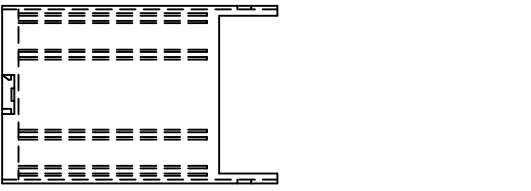

ASSEMBLY

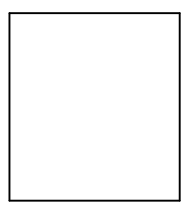

DISPLAY PCB

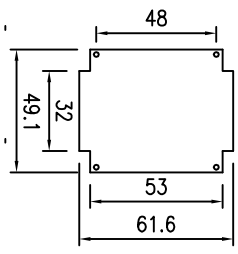

RAIL MOUNTING

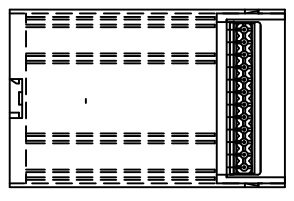
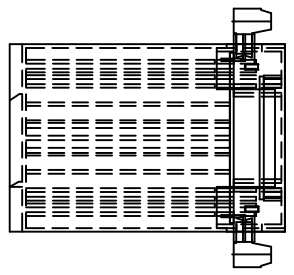

SURFACE MOUNTING

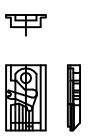
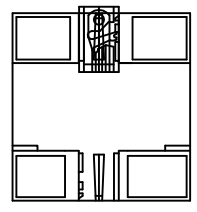
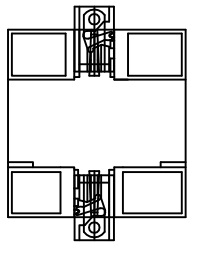

TITLE :	NEW ENCLOSURE DR-24
ITEM NAME:	PLUG-IN TER. PCB HORL
DATE :	AUG 9, 2001
FILE NAME :	DR-24-PTH.DWG